

Plan 4011

Re•Vive at Promontory

Main 1,521 sq. ft.

Total 1,521 sq. ft.

Standard Unfinished Lower 728 sq. ft.
 Opt. Full Unfinished 1,272 sq. ft.
 Opt. Finished Lower 872 sq. ft.

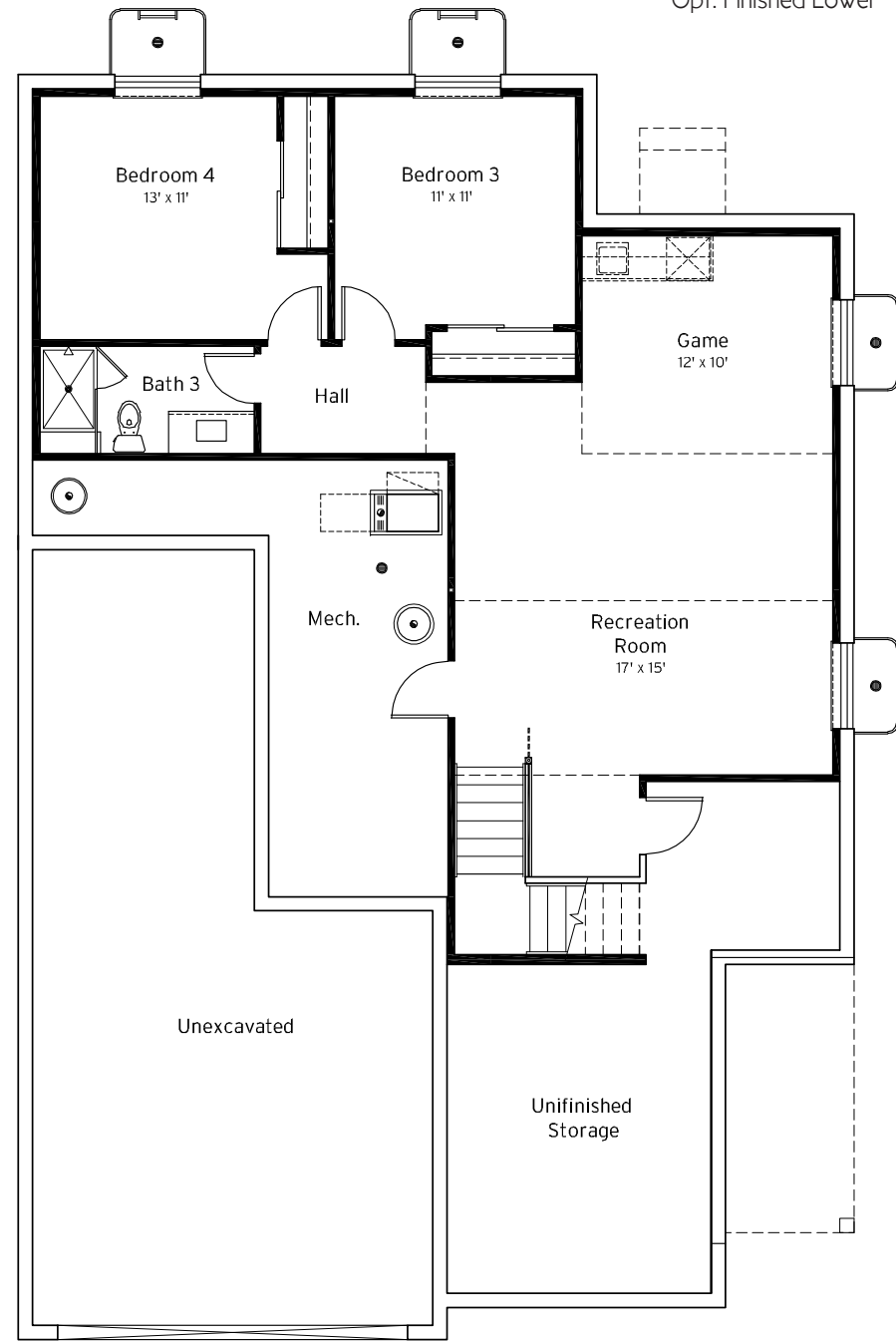

Lower Level Floor Plan

Room sizes are approximate. Floor plans and windows vary by elevation. Drawings are artist's conceptions and are subject to change



Elevation A



Elevation B



Elevation C

Room sizes are approximate. Floor plans and windows vary by elevation. Drawings are artist's conceptions and are subject to change

Plan 4011

Re•Vive at Promontory

Main 1,521 sq. ft.

Total 1,521 sq. ft.

Standard Unfinished Lower 728 sq. ft.
 Opt. Full Unfinished 1,272 sq. ft.
 Opt. Finished Lower 872 sq. ft.



Main Level Floor Plan

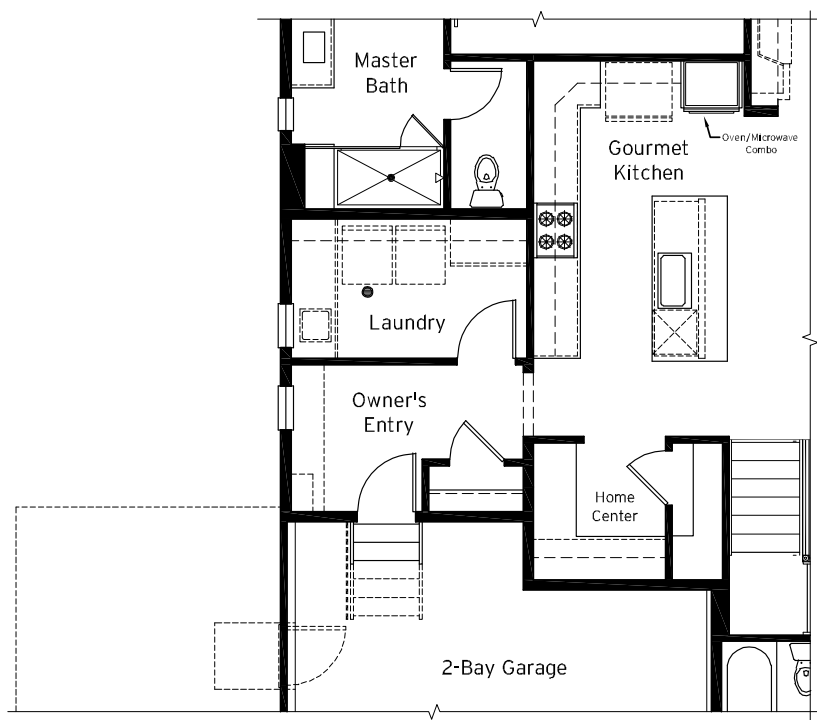

Optional Owner's Entry

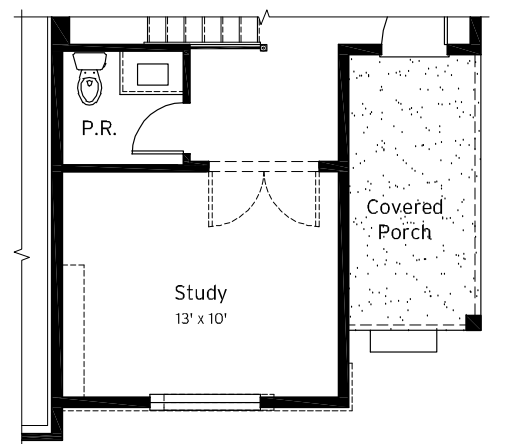

Optional Study

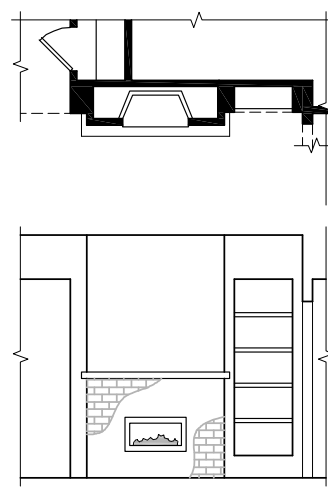

Optional Fireplace

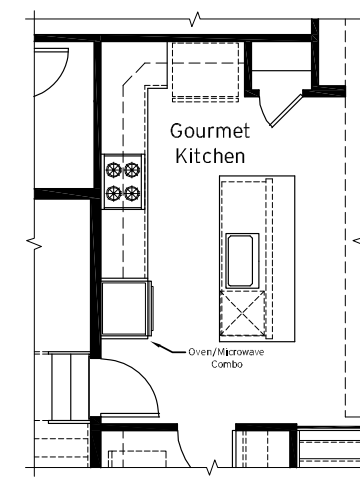

Optional Gourmet Kitchen

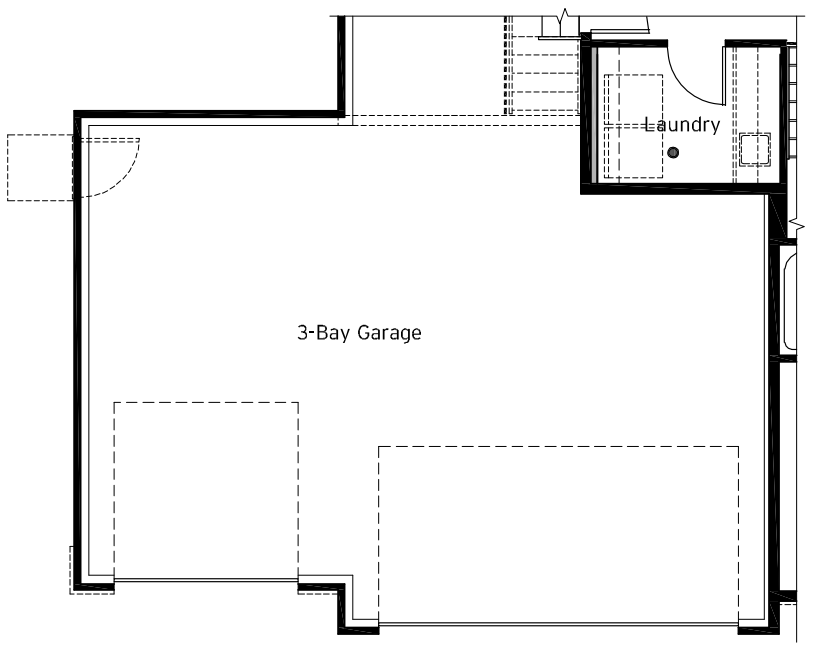

Optional 3 Bay Garage

Room sizes are approximate. Floor plans and windows vary by elevation. Drawings are artist's conceptions and are subject to change

Room sizes are approximate. Floor plans and windows vary by elevation. Drawings are artist's conceptions and are subject to change

Plan 4012
Re•Vive at Promontory

Main 1,737 sq. ft.

Total 1,737 sq. ft.

Standard Unfinished Lower 1,126 sq. ft.
Opt. Full Unfinished 1,540 sq. ft.
Opt. Finished Lower 890 sq. ft.

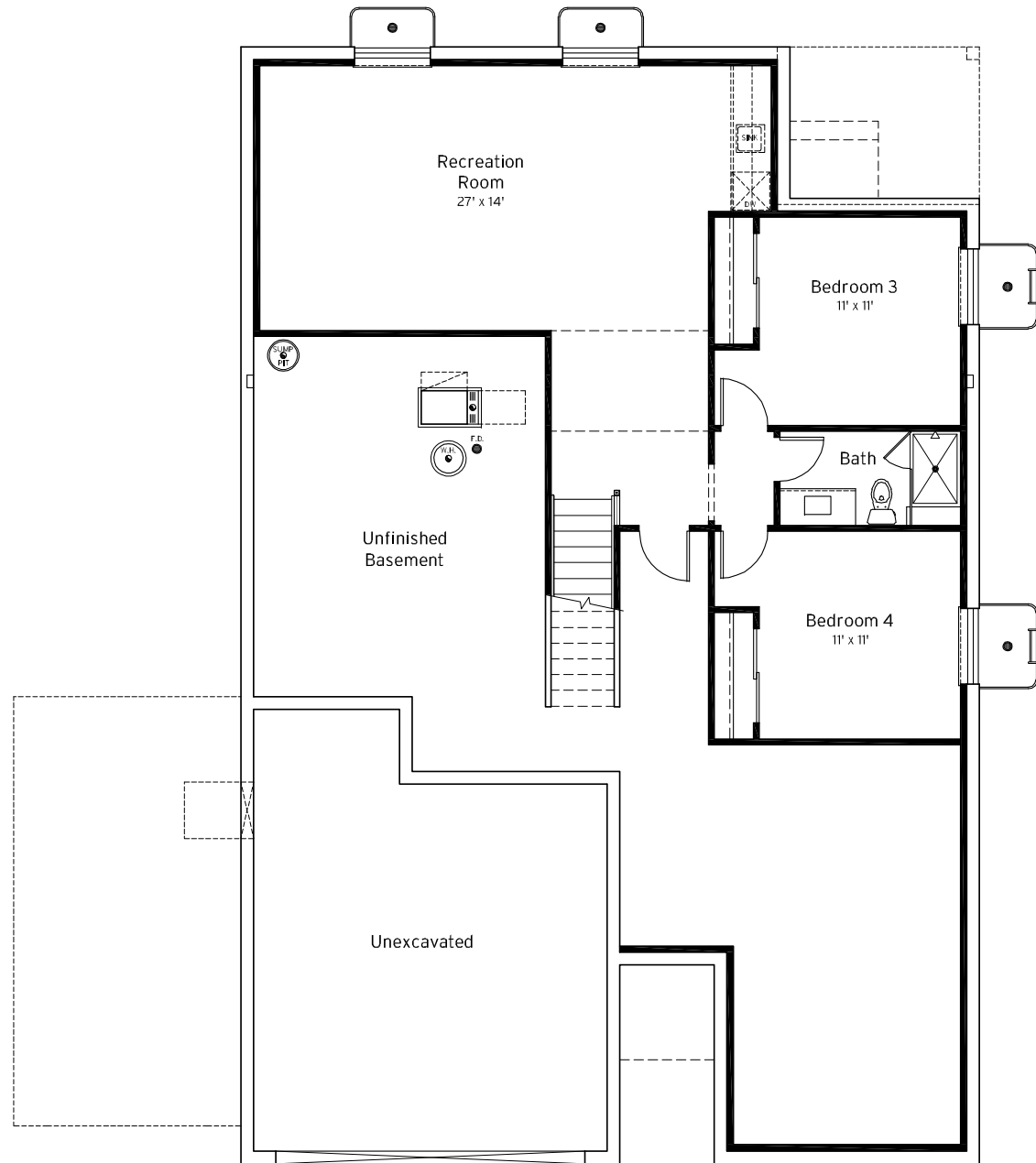

Lower Level Floor Plan

Room sizes are approximate. Floor plans and windows vary by elevation. Drawings are artist's conceptions and are subject to change



Elevation A

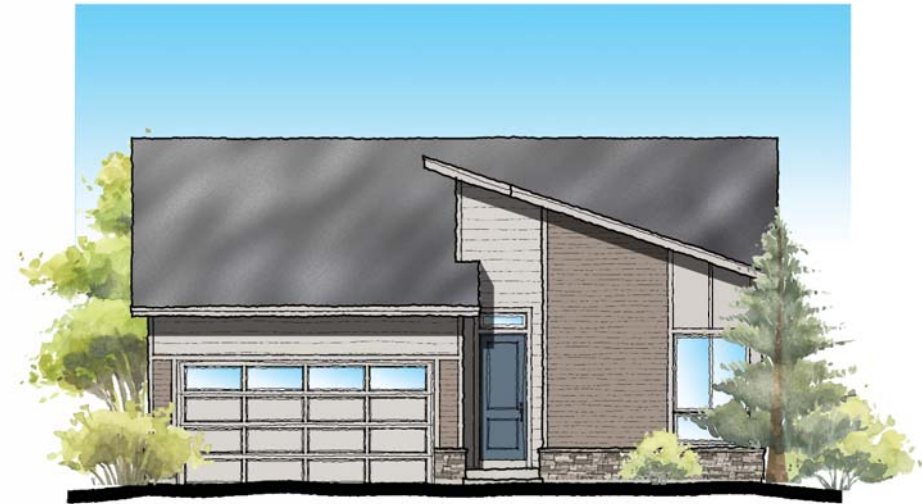

Elevation B

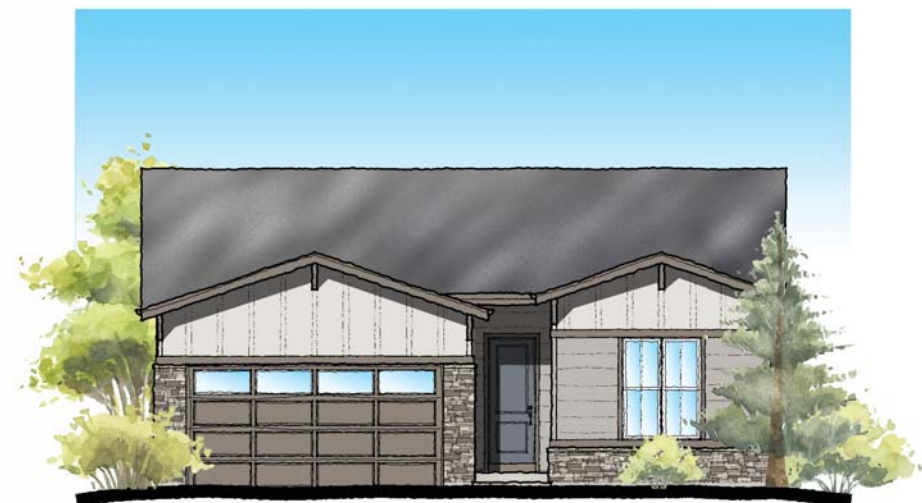

Elevation C

Room sizes are approximate. Floor plans and windows vary by elevation. Drawings are artist's conceptions and are subject to change

Plan 4012

Re•Vive at Promontory

Main 1,737 sq. ft.

Total 1,737 sq. ft.

Standard Unfinished Lower 1,126 sq. ft.
 Opt. Full Unfinished 1,540 sq. ft.
 Opt. Finished Lower 890 sq. ft.



Main Level Floor Plan

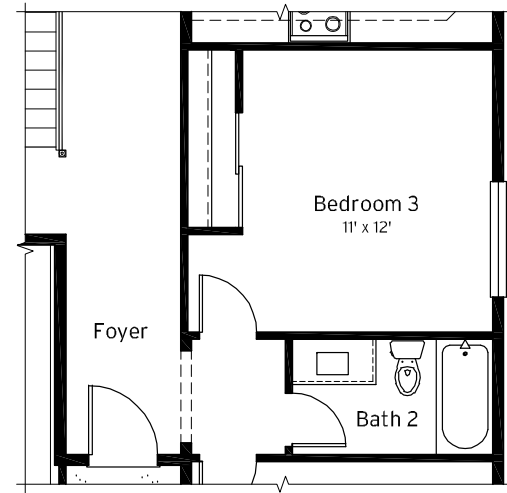

Optional Bedroom 3

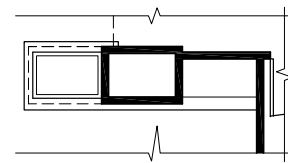

Optional Fireplace

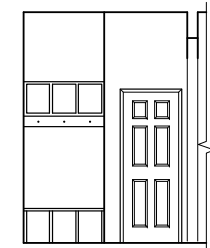

Optional Bench at Entry

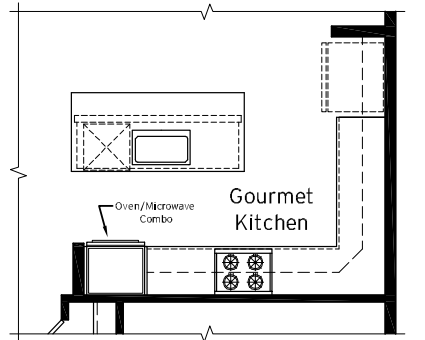

Optional Gourmet Kitchen

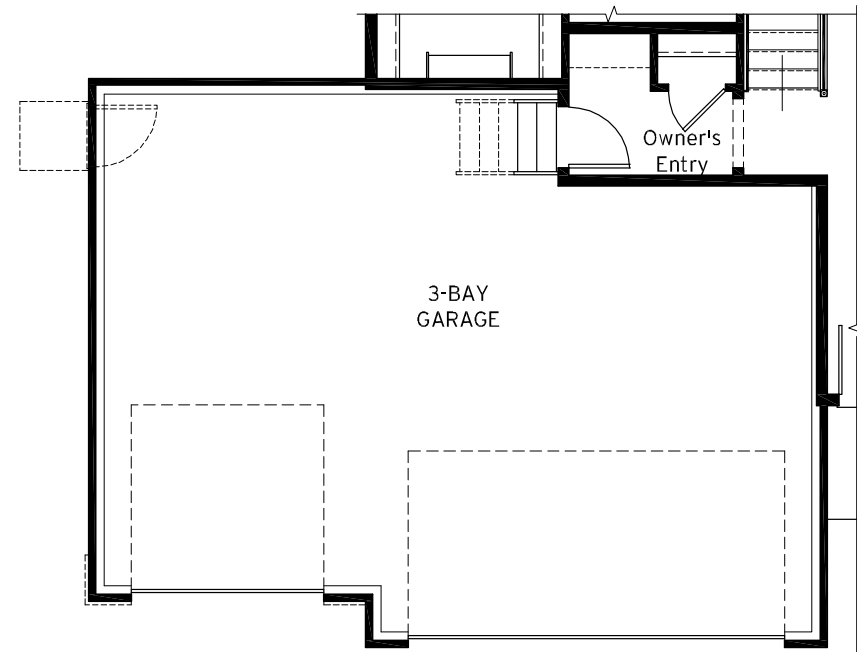

Optional 3 Bay Garage

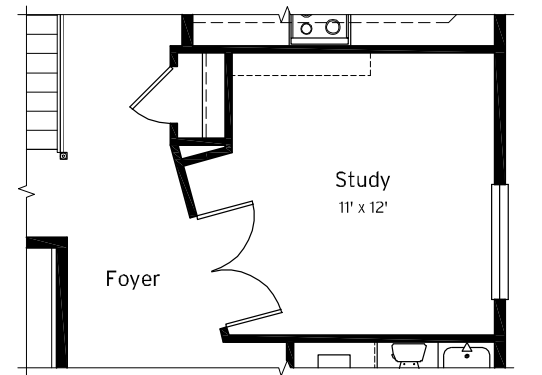

Optional Study

Room sizes are approximate. Floor plans and windows vary by elevation. Drawings are artist's conceptions and are subject to change

Room sizes are approximate. Floor plans and windows vary by elevation. Drawings are artist's conceptions and are subject to change

Plan 4013

Re•Vive at Promontory

Main	1,001 sq. ft.
Upper	1,035 sq. ft.
<hr/>	
Total	2,036 sq. ft.

Standard Unfinished Lower	889 sq. ft.
Opt. Finished Lower	659 sq. ft.

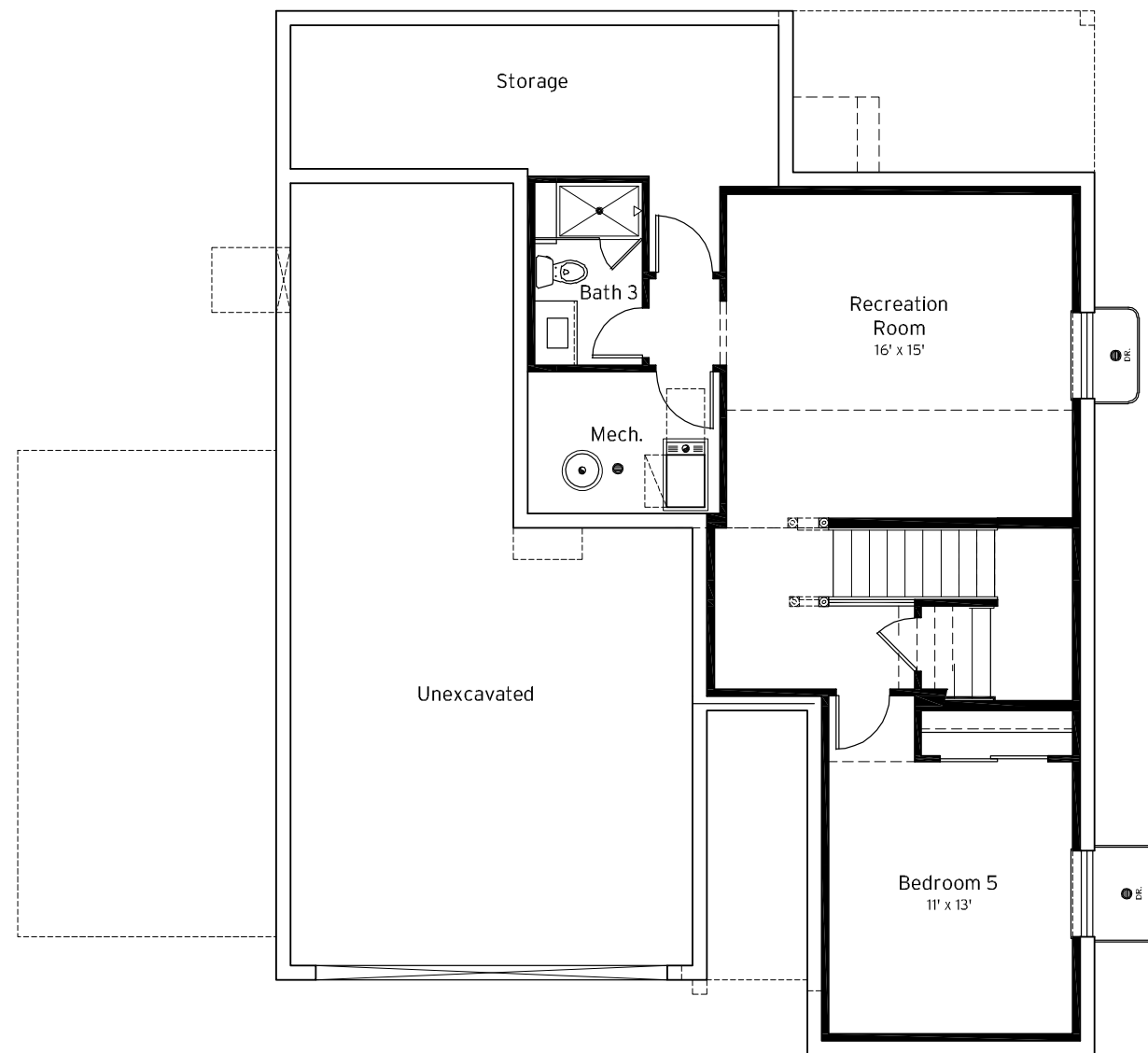

Lower Level Floor Plan

Room sizes are approximate. Floor plans and windows vary by elevation. Drawings are artist's conceptions and are subject to change



Elevation A



Elevation B



Elevation C

Room sizes are approximate. Floor plans and windows vary by elevation. Drawings are artist's conceptions and are subject to change

Plan 4013

Re•Vive at Promontory

Main 1,001 sq. ft.
Upper 1,035 sq. ft.

Total 2,036 sq. ft.

Standard Unfinished Lower 889 sq. ft.
Opt. Finished Lower 659 sq. ft.

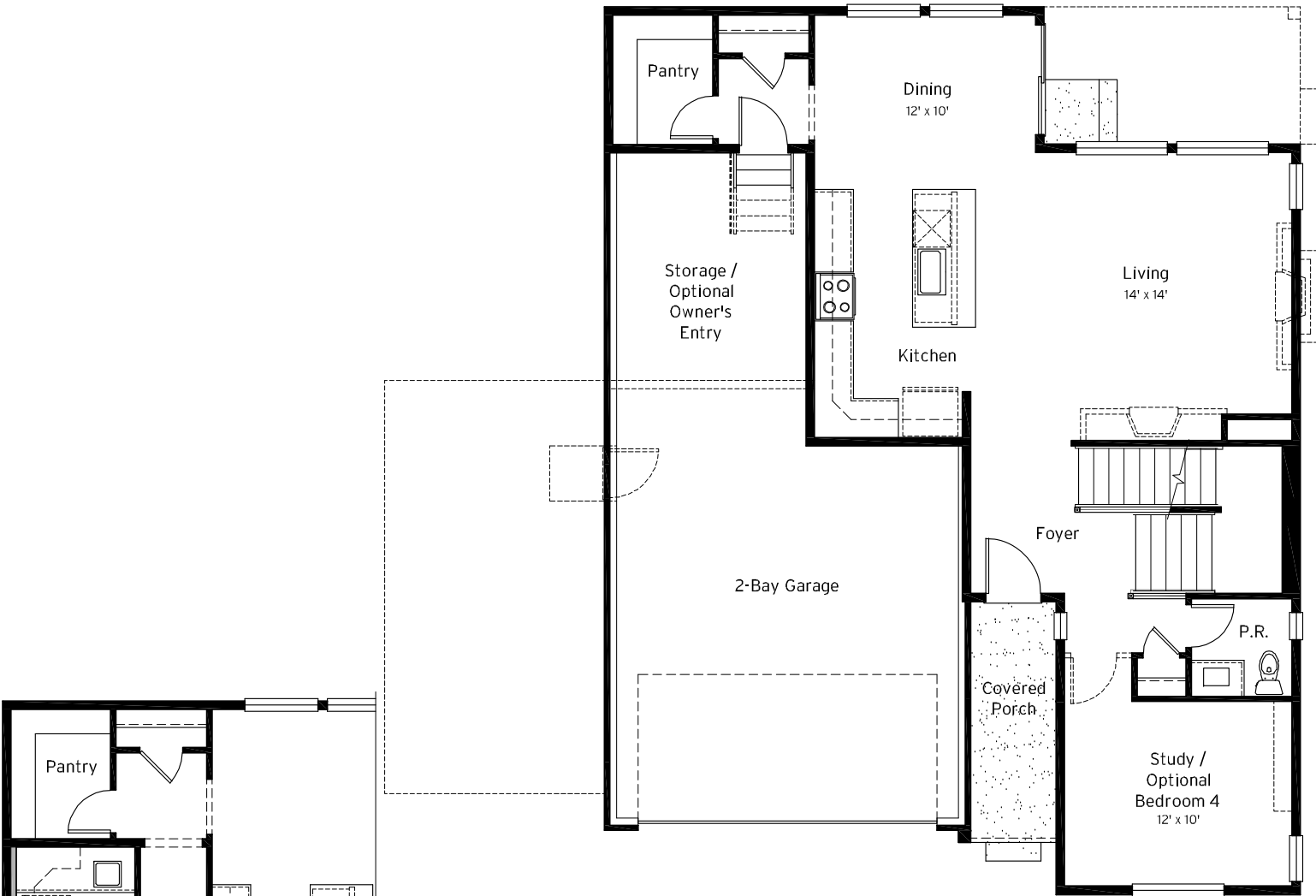

Main Level Floor Plan

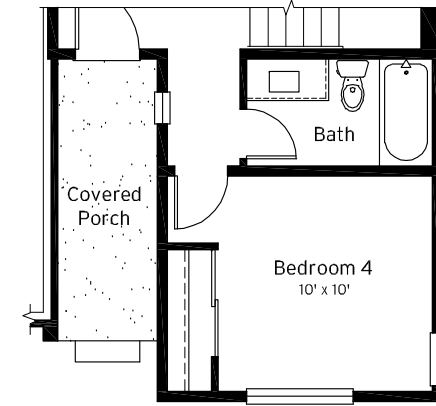

Optional Bedroom 4

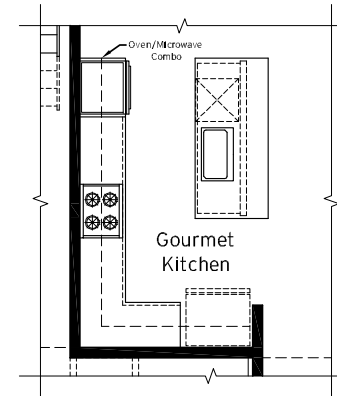

Optional Gourmet Kitchen

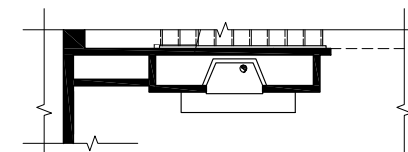

Optional Fireplace

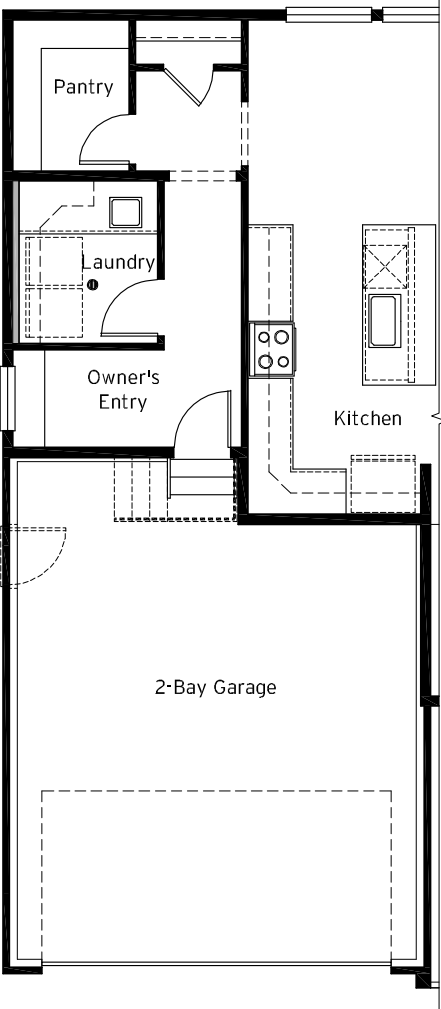

Optional Owner's Entry and Laundry

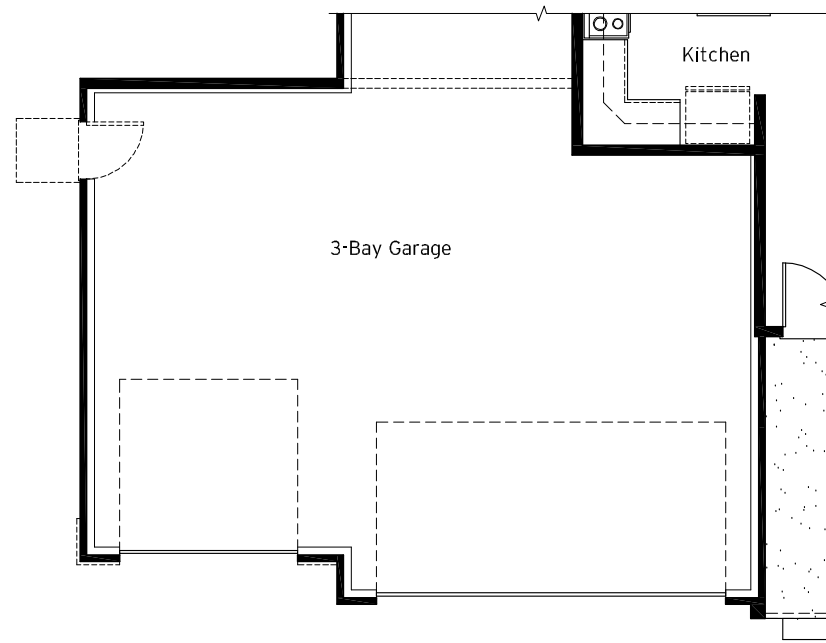

Optional 3 Bay Garage

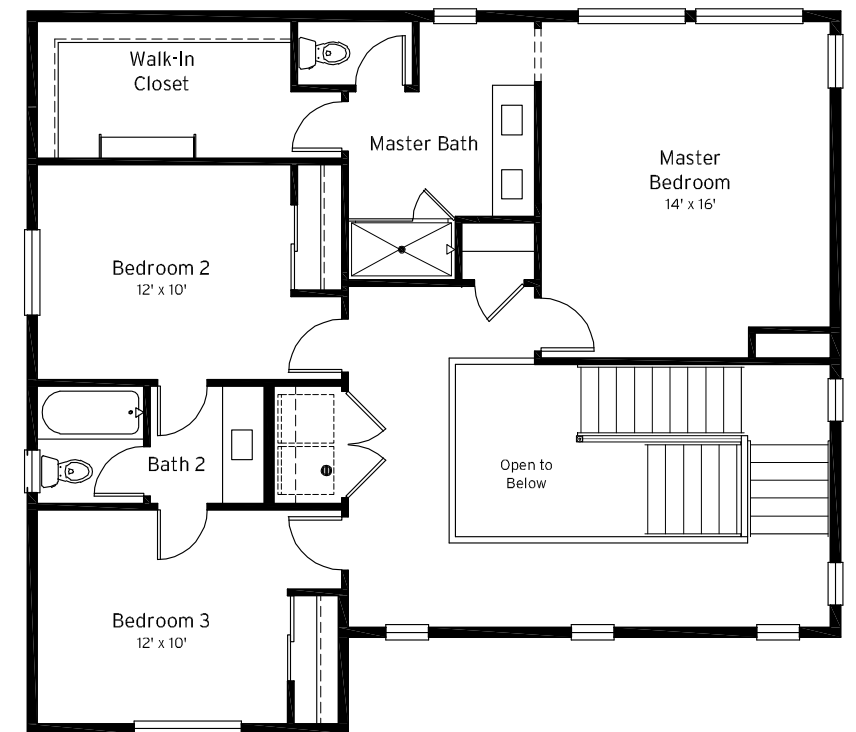

Upper Level Floor Plan

Room sizes are approximate. Floor plans and windows vary by elevation. Drawings are artist's conceptions and are subject to change

Room sizes are approximate. Floor plans and windows vary by elevation. Drawings are artist's conceptions and are subject to change

Plan 4014
Re•Vive at Promontory

Main 1,043 sq. ft.
Lower 1,161 sq. ft.
Total 2,204 sq. ft.

Standard Unfinished Lower 935 sq. ft.
Opt. Finished Lower 600 sq. ft.



Lower Level Floor Plan

Room sizes are approximate. Floor plans and windows vary by elevation. Drawings are artist's conceptions and are subject to change



Elevation A



Elevation B



Elevation C

Room sizes are approximate. Floor plans and windows vary by elevation. Drawings are artist's conceptions and are subject to change

Plan 4014

Re•Vive at Promontory

Main 1,043 sq. ft.
Lower 1,161 sq. ft.

Total 2,204 sq. ft.

Standard Unfinished Lower 935 sq. ft.
Opt. Finished Lower 600 sq. ft.

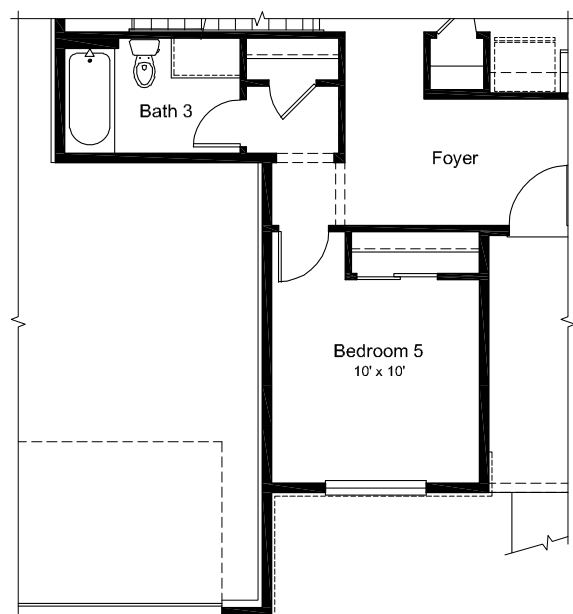

Optional Bedroom 5

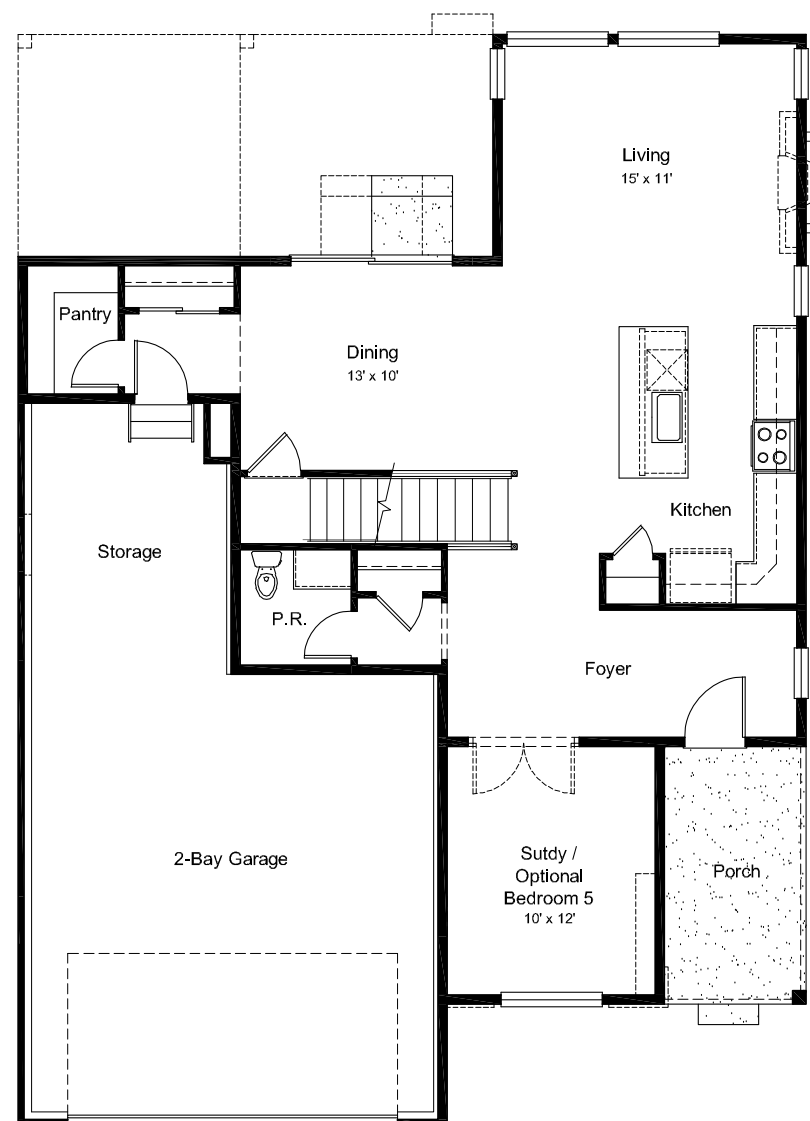

Main Level Floor Plan

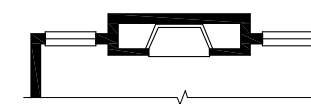

Optional Fireplace

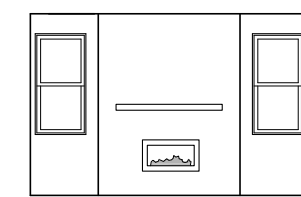

Optional Gourmet Kitchen

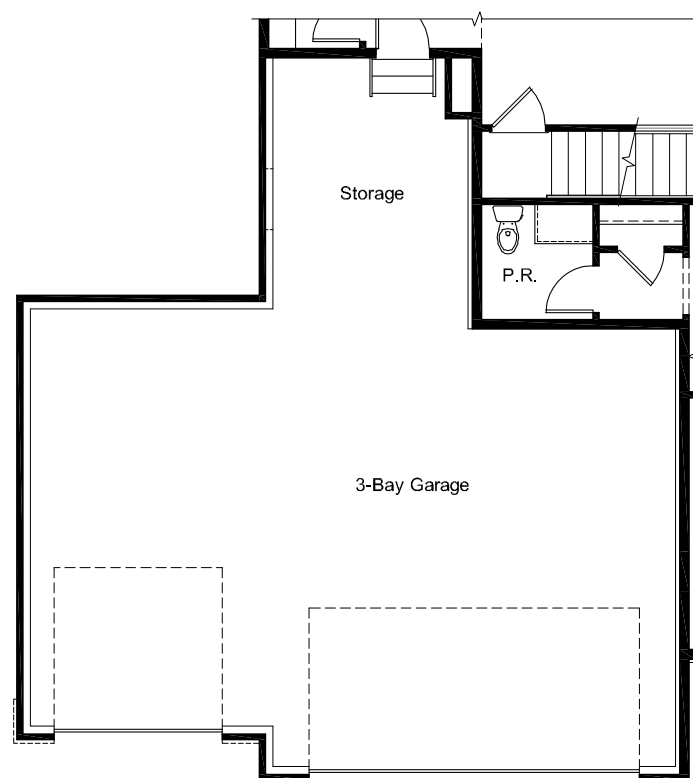
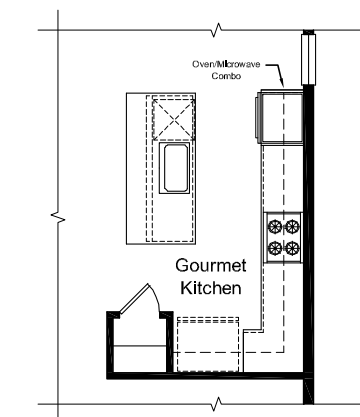

Optional 3 Bay Garage

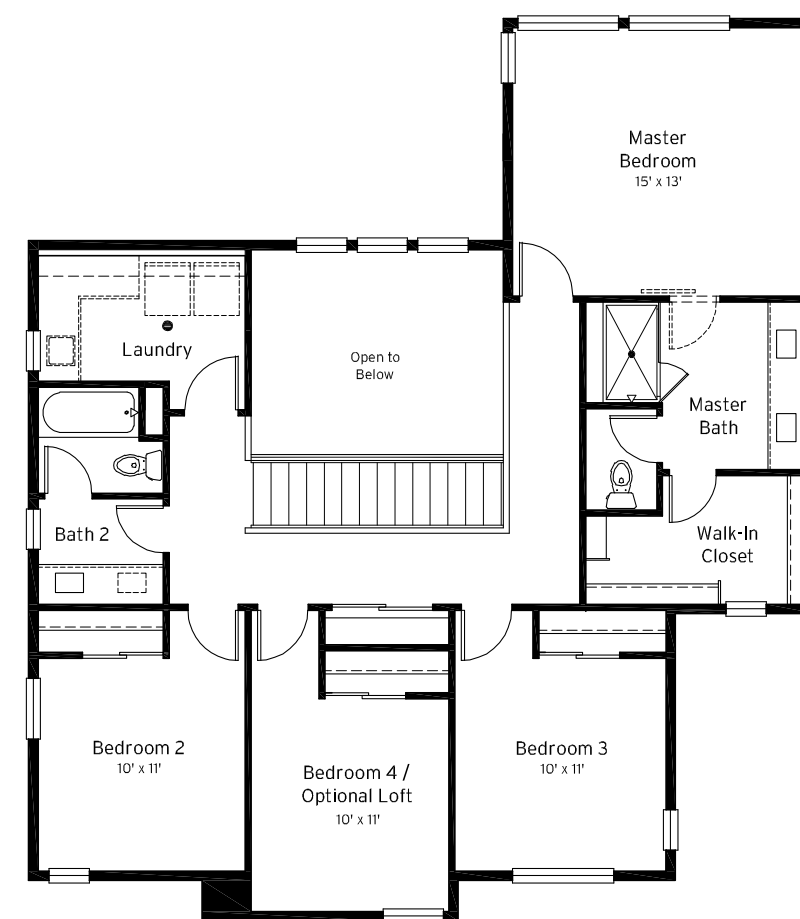

Upper Level Floor Plan

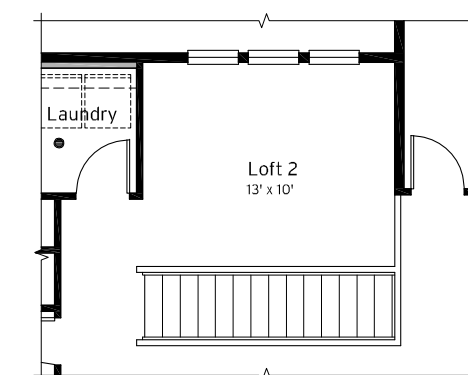

Optional Loft 2

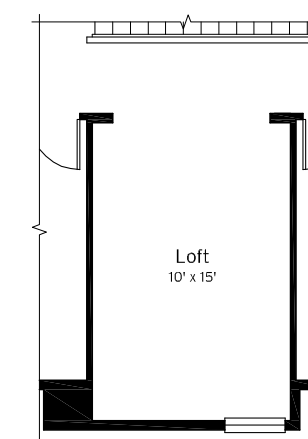

Optional Loft 1

Room sizes are approximate. Floor plans and windows vary by elevation. Drawings are artist's conceptions and are subject to change

Room sizes are approximate. Floor plans and windows vary by elevation. Drawings are artist's conceptions and are subject to change